

Field Effect Transistor - N-Channel, Enhancement Mode

BS170, MMBF170

General Description

These N-Channel enhancement mode field effect transistors are produced using onsemi's proprietary, high cell density, DMOS technology. These products have been designed to minimize on-state resistance while provide rugged, reliable, and fast switching performance. They can be used in most applications requiring up to 500 mA DC. These products are particularly suited for low voltage, low current applications such as small servo motor control, power MOSFET gate drivers, and other switching applications.

Features

- High Density Cell Design for Low $R_{DS(ON)}$
- Voltage Controlled Small Signal Switch
- Rugged and Reliable
- High Saturation Current Capability
- These are Pb-Free Devices

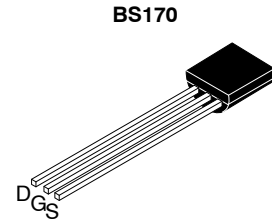

TO-92 3 4.825x4.76
 CASE 135AN

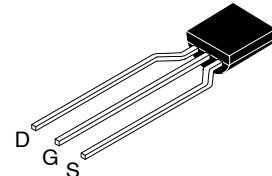

TO-92 3 4.83x4.76 LEADFORMED
 CASE 135AR

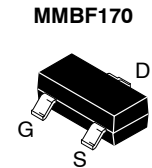

SOT-23
 CASE 318-08

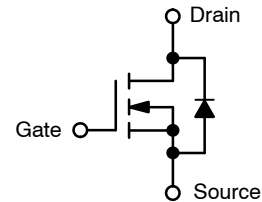

MARKING DIAGRAM

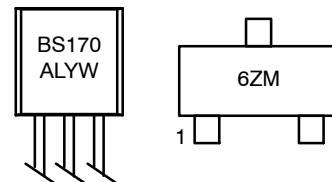

BS170, 6Z = Device Code
 A = Assembly Plant Code
 L = Wafer Lot Number
 YW = Assembly Start Week
 M = Date Code

ORDERING INFORMATION

See detailed ordering and shipping information on page 6 of this data sheet.

BS170, MMBF170

ABSOLUTE MAXIMUM RATINGS (T_A = 25°C unless otherwise noted)

Symbol	Parameter		BS170	MMBF170	Unit
V _{DSS}	Drain–Source Voltage		60		V
V _{DGR}	Drain–Gate Voltage (R _{GS} ≤ 1 MΩ)		60		V
V _{GSS}	Gate–Source Voltage		±20		V
I _D	Drain Current	– Continuous	500	500	mA
		– Pulsed	1200	800	
T _J , T _{STG}	Operating and Storage Temperature Range		– 55 to 150		°C
T _L	Maximum Lead Temperature for Soldering Purposes, 1/16" from Case for 10 Seconds		300		°C

Stresses exceeding those listed in the Maximum Ratings table may damage the device. If any of these limits are exceeded, device functionality should not be assumed, damage may occur and reliability may be affected.

THERMAL CHARACTERISTICS (T_A = 25°C unless otherwise noted)

Symbol	Parameter	BS170	MMBF170	Unit
P _D	Maximum Power Dissipation Derate above 25°C	830	300	mW mW/°C
		6.6	2.4	
R _{θJA}	Thermal Resistance, Junction to Ambient	150	417	°C/W

ELECTRICAL CHARACTERISTICS (T_A = 25°C unless otherwise noted)

Symbol	Parameter	Test Condition	Type	Min	Typ	Max	Unit
--------	-----------	----------------	------	-----	-----	-----	------

OFF CHARACTERISTICS

BV _{DSS}	Drain–Source Breakdown Voltage	V _{GS} = 0 V, I _D = 100 μA	All	60	–	–	V
I _{DSS}	Zero Gate Voltage Drain Current	V _{DS} = 25 V, V _{GS} = 0 V	All	–	–	0.5	μA
I _{GSSF}	Gate – Body Leakage, Forward	V _{GS} = 15 V, V _{DS} = 0 V	All	–	–	10	nA

ON CHARACTERISTICS (Note 1)

V _{GS(th)}	Gate Threshold Voltage	V _{DS} = V _{GS} , I _D = 1 mA	All	0.8	2.1	3	V
R _{DS(ON)}	Static Drain–Source On–Resistance	V _{GS} = 10 V, I _D = 200 mA	All	–	1.2	5	Ω
g _{FS}	Forward Transconductance	V _{DS} = 10 V, I _D = 200 mA	BS170	–	320	–	mS
		V _{DS} ≥ 2 V _{DS(on)} , I _D = 200 mA	MMBF170	–	320	–	

DYNAMIC CHARACTERISTICS

C _{iss}	Input Capacitance	V _{DS} = 10 V, V _{GS} = 0 V, f = 1.0 MHz	All	–	24	40	pF
C _{OSS}	Output Capacitance		All	–	17	30	pF
C _{rss}	Reverse Transfer Capacitance		All	–	7	10	pF

SWITCHING CHARACTERISTICS (Note 1)

t _{on}	Turn–On Time	V _{DD} = 25 V, I _D = 200 mA, V _{GS} = 10 V, R _{GEN} = 25 Ω	BS170	–	–	10	ns
		V _{DD} = 25 V, I _D = 500 mA, V _{GS} = 10 V, R _{GEN} = 50 Ω	MMBF170	–	–	10	
t _{off}	Turn–Off Time	V _{DD} = 25 V, I _D = 200 mA, V _{GS} = 10 V, R _{GEN} = 25 Ω	BS170	–	–	10	ns
		V _{DD} = 25 V, I _D = 500 mA, V _{GS} = 10 V, R _{GEN} = 50 Ω	MMBF170	–	–	10	

Product parametric performance is indicated in the Electrical Characteristics for the listed test conditions, unless otherwise noted. Product performance may not be indicated by the Electrical Characteristics if operated under different conditions.

1. Pulse Test: Pulse Width ≤ 300 μs, Duty Cycle ≤ 2.0%.

BS170, MMBF170

TYPICAL ELECTRICAL CHARACTERISTICS

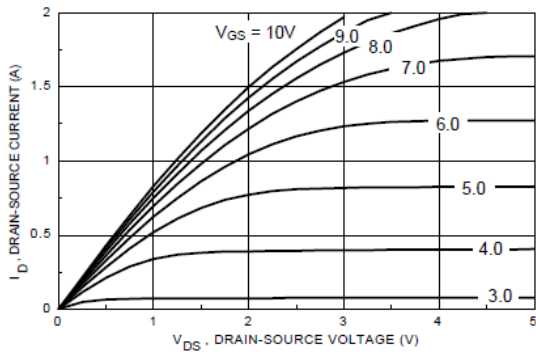

Figure 1. On-Region Characteristics

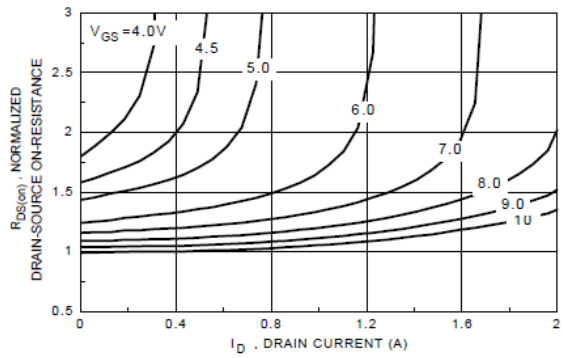

Figure 2. On-Resistance Variation with Gate Voltage and Drain Current

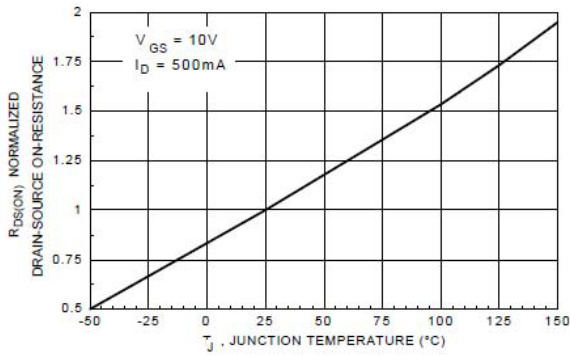

Figure 3. On-Resistance Variation with Temperature

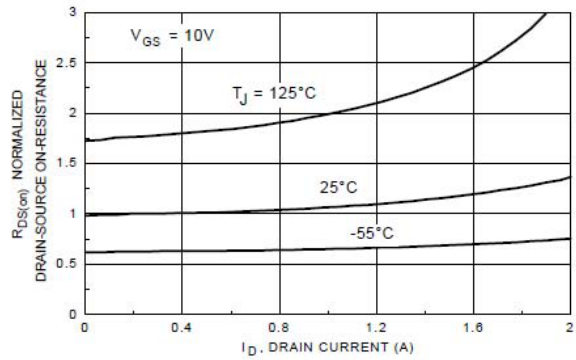

Figure 4. On-Resistance Variation with Drain Current and Temperature

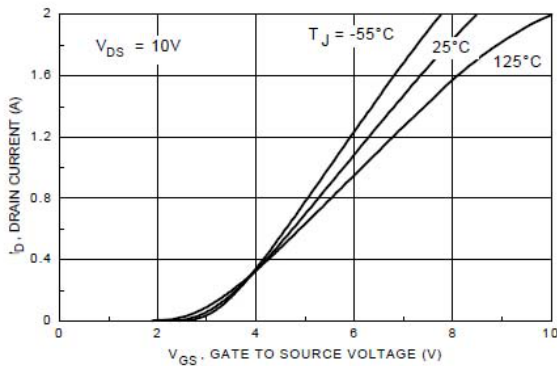

Figure 5. Transfer Characteristics

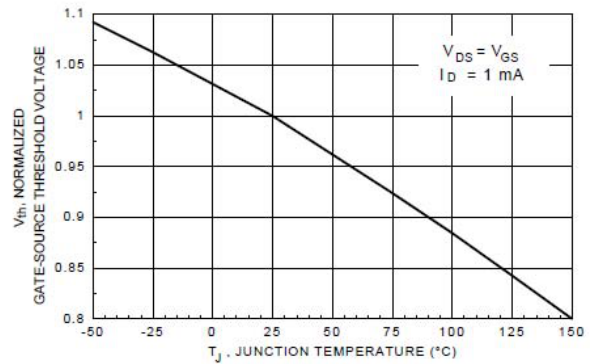

Figure 6. Gate Threshold Variation with Temperature

TYPICAL ELECTRICAL CHARACTERISTICS (continued)

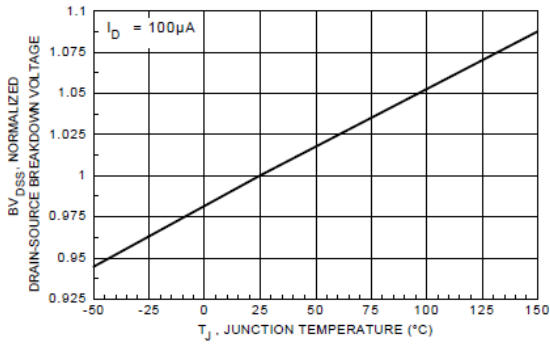

Figure 7. Breakdown Voltage Variation with Temperature

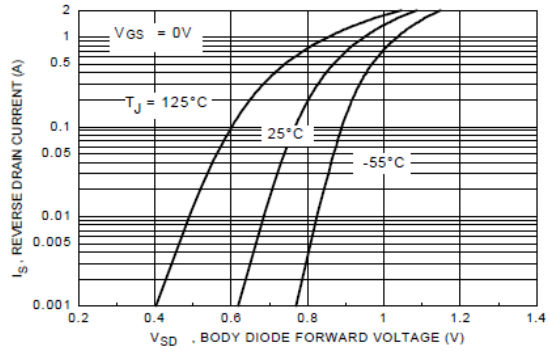

Figure 8. Body Diode Forward Voltage Variation with Current and Temperature

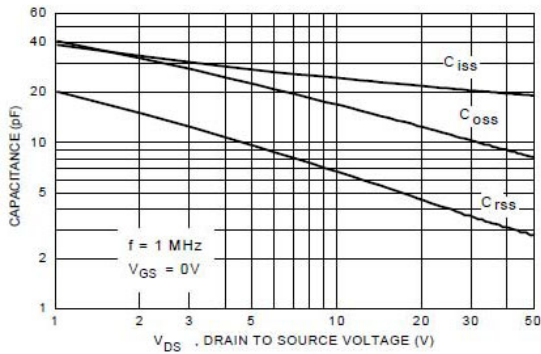

Figure 9. Capacitance Characteristics

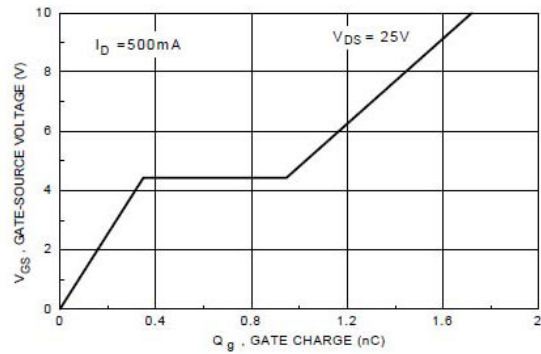

Figure 10. Gate Charge Characteristics

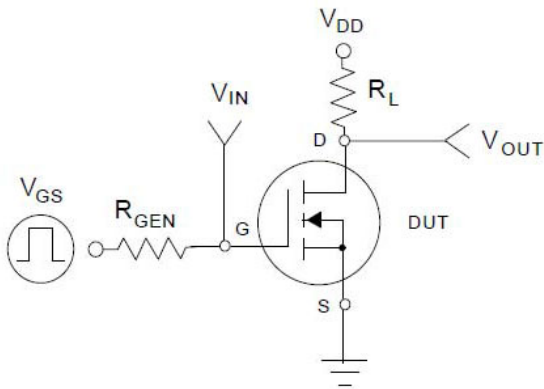

Figure 11. Switching Test Circuit

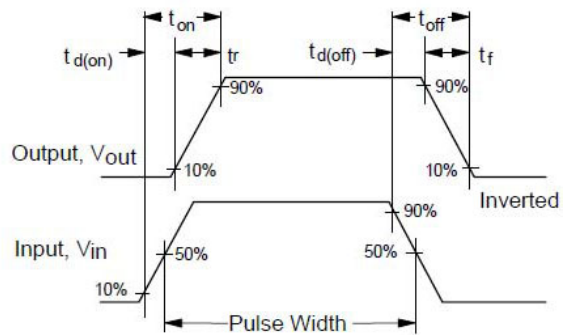

Figure 12. Switching Waveforms

BS170, MMBF170

TYPICAL ELECTRICAL CHARACTERISTICS (continued)

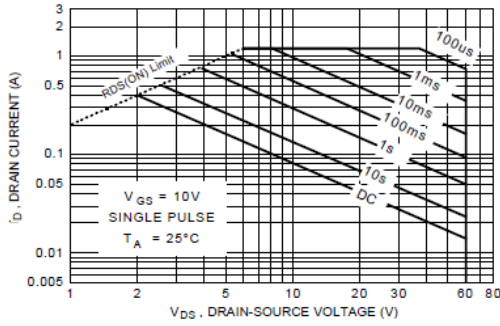

Figure 13. BS170 Maximum Safe Operating Area

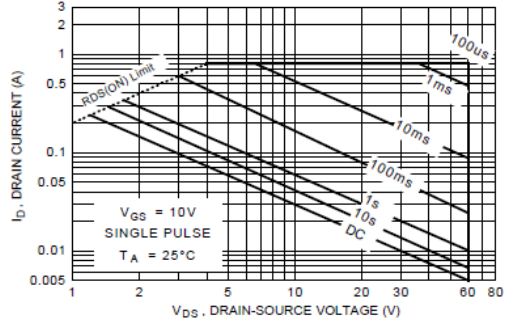

Figure 14. MMBF170 Maximum Safe Operating Area

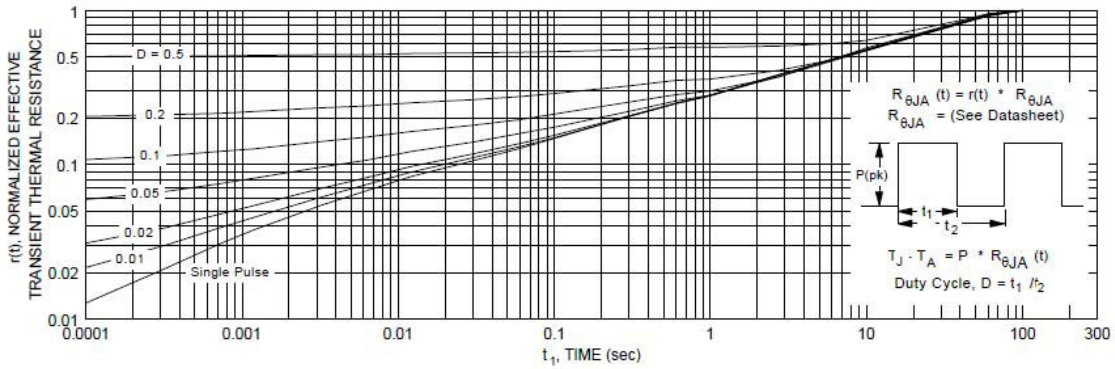

Figure 15. TO-92, BS170 Transient Thermal Response Curve

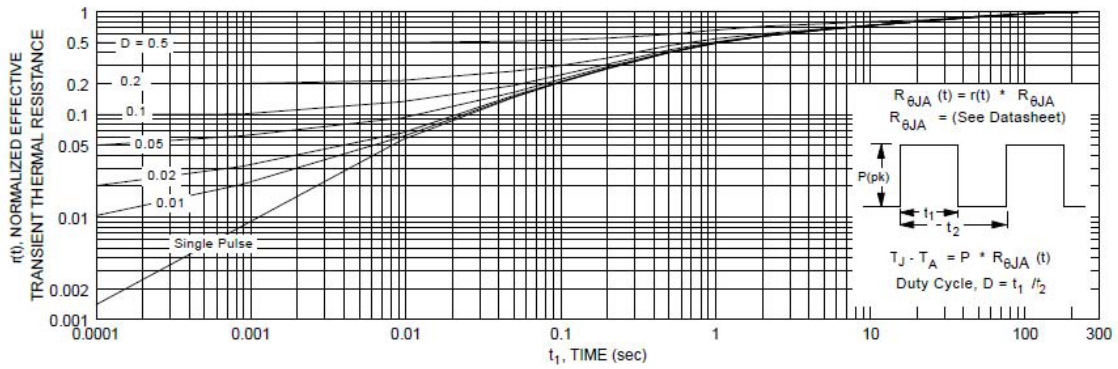

Figure 16. SOT-23, MMBF170 Transient Thermal Response Curve

BS170, MMBF170

ORDERING INFORMATION

Part Number	Package	Lead Frame	Pin Array	Shipping [†]
BS170	TO-92 (Pb-Free)	Straight	D G S	10000 Units / Bulk
BS170-D26Z	TO-92 (Pb-Free)	Forming	D G S	2000 / Tape & Reel
BS170-D27Z	TO-92 (Pb-Free)	Forming	D G S	2000 / Tape & Reel
BS170-D74Z	TO-92 (Pb-Free)	Forming	D G S	2000 / Ammo
BS170-D75Z	TO-92 (Pb-Free)	Forming	D G S	2000 / Ammo
MMBF170	SOT-23 (Pb-Free)			3000 / Tape & Reel

[†]For information on tape and reel specifications, including part orientation and tape sizes, please refer to our Tape and Reel Packaging Specifications Brochure, BRD8011/D.

MECHANICAL CASE OUTLINE
PACKAGE DIMENSIONS

TO-92 3 4.825x4.76
CASE 135AN
ISSUE O

DATE 31 JUL 2016



NOTES: UNLESS OTHERWISE SPECIFIED

- A) DRAWING WITH REFERENCE TO JEDEC TO-92 RECOMMENDATIONS.
- B) ALL DIMENSIONS ARE IN MILLIMETERS.
- C) DRAWING CONFORMS TO ASME Y14.5M-2009.

DOCUMENT NUMBER:	98AON13880G	Electronic versions are uncontrolled except when accessed directly from the Document Repository. Printed versions are uncontrolled except when stamped "CONTROLLED COPY" in red.
DESCRIPTION:	TO-92 3 4.825X4.76	PAGE 1 OF 1

ON Semiconductor and **ON** are trademarks of Semiconductor Components Industries, LLC dba ON Semiconductor or its subsidiaries in the United States and/or other countries. ON Semiconductor reserves the right to make changes without further notice to any products herein. ON Semiconductor makes no warranty, representation or guarantee regarding the suitability of its products for any particular purpose, nor does ON Semiconductor assume any liability arising out of the application or use of any product or circuit, and specifically disclaims any and all liability, including without limitation special, consequential or incidental damages. ON Semiconductor does not convey any license under its patent rights nor the rights of others.

MECHANICAL CASE OUTLINE
PACKAGE DIMENSIONS

TO-92 3 4.83x4.76 LEADFORMED
CASE 135AR
ISSUE O

DATE 30 SEP 2016

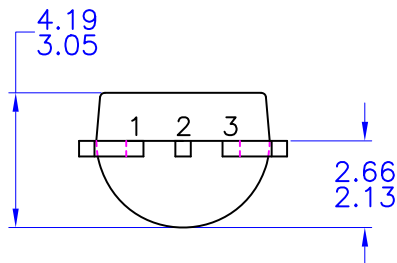
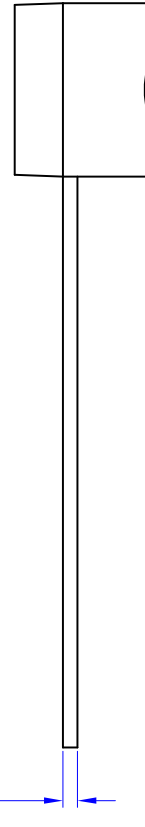
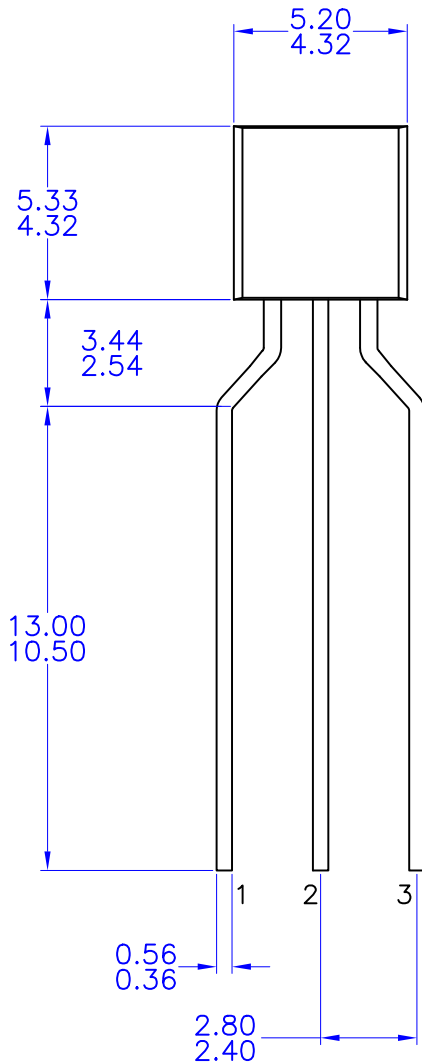

NOTES: UNLESS OTHERWISE SPECIFIED

- A) DRAWING WITH REFERENCE TO JEDEC TO-92 RECOMMENDATIONS.
- B) ALL DIMENSIONS ARE IN MILLIMETERS.
- C) DRAWING CONFORMS TO ASME Y14.5M-1994

DOCUMENT NUMBER:	98AON13879G	Electronic versions are uncontrolled except when accessed directly from the Document Repository. Printed versions are uncontrolled except when stamped "CONTROLLED COPY" in red.
DESCRIPTION:	TO-92 3 4.83X4.76 LEADFORMED	PAGE 1 OF 1

ON Semiconductor and  are trademarks of Semiconductor Components Industries, LLC dba ON Semiconductor or its subsidiaries in the United States and/or other countries. ON Semiconductor reserves the right to make changes without further notice to any products herein. ON Semiconductor makes no warranty, representation or guarantee regarding the suitability of its products for any particular purpose, nor does ON Semiconductor assume any liability arising out of the application or use of any product or circuit, and specifically disclaims any and all liability, including without limitation special, consequential or incidental damages. ON Semiconductor does not convey any license under its patent rights nor the rights of others.

MECHANICAL CASE OUTLINE

PACKAGE DIMENSIONS

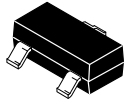

SOT-23 (TO-236)
CASE 318
ISSUE AT

DATE 01 MAR 2023

SCALE 4:1

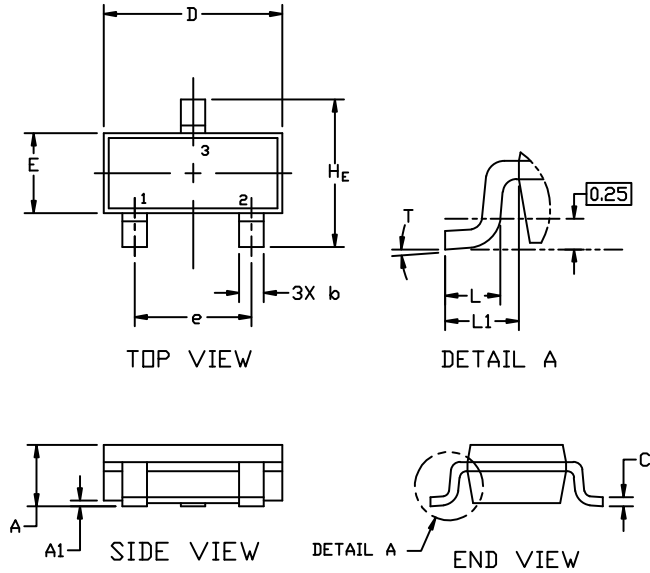

NOTES:

1. DIMENSIONING AND TOLERANCING PER ASME Y14.5M,1994.
2. CONTROLLING DIMENSION: MILLIMETERS
3. MAXIMUM LEAD THICKNESS INCLUDES LEAD FINISH. MINIMUM LEAD THICKNESS IS THE MINIMUM THICKNESS OF THE BASE MATERIAL.
4. DIMENSIONS D AND E DO NOT INCLUDE MOLD FLASH, PROTRUSIONS, OR GATE BURRS.

DIM	MILLIMETERS			INCHES		
	MIN.	NOM.	MAX.	MIN.	NOM.	MAX.
A	0.89	1.00	1.11	0.035	0.039	0.044
A1	0.01	0.06	0.10	0.000	0.002	0.004
b	0.37	0.44	0.50	0.015	0.017	0.020
c	0.08	0.14	0.20	0.003	0.006	0.008
D	2.80	2.90	3.04	0.110	0.114	0.120
E	1.20	1.30	1.40	0.047	0.051	0.055
e	1.78	1.90	2.04	0.070	0.075	0.080
L	0.30	0.43	0.55	0.012	0.017	0.022
L1	0.35	0.54	0.69	0.014	0.021	0.027
H _E	2.10	2.40	2.64	0.083	0.094	0.104
T	0°	---	10°	0°	---	10°

GENERIC MARKING DIAGRAM*

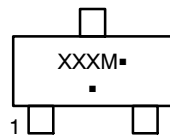

- XXX = Specific Device Code
- M = Date Code
- = Pb-Free Package

*This information is generic. Please refer to device data sheet for actual part marking. Pb-Free indicator, "G" or microdot "▪", may or may not be present. Some products may not follow the Generic Marking.

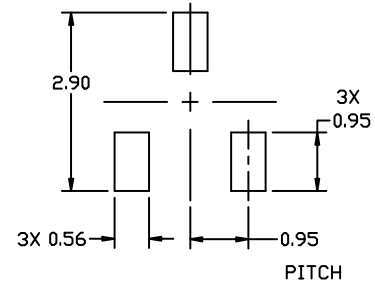

RECOMMENDED MOUNTING FOOTPRINT

* For additional information on our Pb-Free strategy and soldering details, please download the ON Semiconductor Soldering and Mounting Techniques Reference Manual, SOLDERRM/D.

STYLES ON PAGE 2

DOCUMENT NUMBER:	98ASB42226B	Electronic versions are uncontrolled except when accessed directly from the Document Repository. Printed versions are uncontrolled except when stamped "CONTROLLED COPY" in red.
DESCRIPTION:	SOT-23 (TO-236)	PAGE 1 OF 2

onsemi and ONSEMI are trademarks of Semiconductor Components Industries, LLC dba onsemi or its subsidiaries in the United States and/or other countries. onsemi reserves the right to make changes without further notice to any products herein. onsemi makes no warranty, representation or guarantee regarding the suitability of its products for any particular purpose, nor does onsemi assume any liability arising out of the application or use of any product or circuit, and specifically disclaims any and all liability, including without limitation special, consequential or incidental damages. onsemi does not convey any license under its patent rights nor the rights of others.

MECHANICAL CASE OUTLINE

PACKAGE DIMENSIONS



SOT-23 (TO-236) CASE 318 ISSUE AT

DATE 01 MAR 2023

STYLE 1 THRU 5: CANCELLED	STYLE 6: PIN 1. BASE 2. EMITTER 3. COLLECTOR	STYLE 7: PIN 1. EMITTER 2. BASE 3. COLLECTOR	STYLE 8: PIN 1. ANODE 2. NO CONNECTION 3. CATHODE		
STYLE 9: PIN 1. ANODE 2. ANODE 3. CATHODE	STYLE 10: PIN 1. DRAIN 2. SOURCE 3. GATE	STYLE 11: PIN 1. ANODE 2. CATHODE 3. CATHODE-ANODE	STYLE 12: PIN 1. CATHODE 2. CATHODE 3. ANODE	STYLE 13: PIN 1. SOURCE 2. DRAIN 3. GATE	STYLE 14: PIN 1. CATHODE 2. GATE 3. ANODE
STYLE 15: PIN 1. GATE 2. CATHODE 3. ANODE	STYLE 16: PIN 1. ANODE 2. CATHODE 3. CATHODE	STYLE 17: PIN 1. NO CONNECTION 2. ANODE 3. CATHODE	STYLE 18: PIN 1. NO CONNECTION 2. CATHODE 3. ANODE	STYLE 19: PIN 1. CATHODE 2. ANODE 3. CATHODE-ANODE	STYLE 20: PIN 1. CATHODE 2. ANODE 3. GATE
STYLE 21: PIN 1. GATE 2. SOURCE 3. DRAIN	STYLE 22: PIN 1. RETURN 2. OUTPUT 3. INPUT	STYLE 23: PIN 1. ANODE 2. ANODE 3. CATHODE	STYLE 24: PIN 1. GATE 2. DRAIN 3. SOURCE	STYLE 25: PIN 1. ANODE 2. CATHODE 3. GATE	STYLE 26: PIN 1. CATHODE 2. ANODE 3. NO CONNECTION
STYLE 27: PIN 1. CATHODE 2. CATHODE 3. CATHODE	STYLE 28: PIN 1. ANODE 2. ANODE 3. ANODE				

DOCUMENT NUMBER:	98ASB42226B	Electronic versions are uncontrolled except when accessed directly from the Document Repository. Printed versions are uncontrolled except when stamped "CONTROLLED COPY" in red.
DESCRIPTION:	SOT-23 (TO-236)	PAGE 2 OF 2

onsemi and **ONSEMI** are trademarks of Semiconductor Components Industries, LLC dba **onsemi** or its subsidiaries in the United States and/or other countries. **onsemi** reserves the right to make changes without further notice to any products herein. **onsemi** makes no warranty, representation or guarantee regarding the suitability of its products for any particular purpose, nor does **onsemi** assume any liability arising out of the application or use of any product or circuit, and specifically disclaims any and all liability, including without limitation special, consequential or incidental damages. **onsemi** does not convey any license under its patent rights nor the rights of others.

onsemi, **Onsemi**, and other names, marks, and brands are registered and/or common law trademarks of Semiconductor Components Industries, LLC dba "**onsemi**" or its affiliates and/or subsidiaries in the United States and/or other countries. **onsemi** owns the rights to a number of patents, trademarks, copyrights, trade secrets, and other intellectual property. A listing of **onsemi**'s product/patent coverage may be accessed at www.onsemi.com/site/pdf/Patent-Marking.pdf. **onsemi** reserves the right to make changes at any time to any products or information herein, without notice. The information herein is provided "as-is" and **onsemi** makes no warranty, representation or guarantee regarding the accuracy of the information, product features, availability, functionality, or suitability of its products for any particular purpose, nor does **onsemi** assume any liability arising out of the application or use of any product or circuit, and specifically disclaims any and all liability, including without limitation special, consequential or incidental damages. Buyer is responsible for its products and applications using **onsemi** products, including compliance with all laws, regulations and safety requirements or standards, regardless of any support or applications information provided by **onsemi**. "Typical" parameters which may be provided in **onsemi** data sheets and/or specifications can and do vary in different applications and actual performance may vary over time. All operating parameters, including "Typicals" must be validated for each customer application by customer's technical experts. **onsemi** does not convey any license under any of its intellectual property rights nor the rights of others. **onsemi** products are not designed, intended, or authorized for use as a critical component in life support systems or any FDA Class 3 medical devices or medical devices with a same or similar classification in a foreign jurisdiction or any devices intended for implantation in the human body. Should Buyer purchase or use **onsemi** products for any such unintended or unauthorized application, Buyer shall indemnify and hold **onsemi** and its officers, employees, subsidiaries, affiliates, and distributors harmless against all claims, costs, damages, and expenses, and reasonable attorney fees arising out of, directly or indirectly, any claim of personal injury or death associated with such unintended or unauthorized use, even if such claim alleges that **onsemi** was negligent regarding the design or manufacture of the part. **onsemi** is an Equal Opportunity/Affirmative Action Employer. This literature is subject to all applicable copyright laws and is not for resale in any manner.

ADDITIONAL INFORMATION

TECHNICAL PUBLICATIONS:

Technical Library: www.onsemi.com/design/resources/technical-documentation
onsemi Website: www.onsemi.com

ONLINE SUPPORT: www.onsemi.com/support

For additional information, please contact your local Sales Representative at www.onsemi.com/support/sales